

NOTICE  
 THIS DRAWING CONTAINS A PROPRIETARY DESIGN ASSIGNED TO SPIRA INTERNATIONAL, INC. ALL RIGHTS TO DUPLICATE, TRANSFER OR SELL THIS DESIGN ARE EXPRESSLY RESERVED. THE BUYER IS LICENSED TO BUILD ONE ASSEMBLY FROM THESE PLANS.

REVISIONS				
ZONE	LTR	DESCRIPTION	DATE	APPROVED

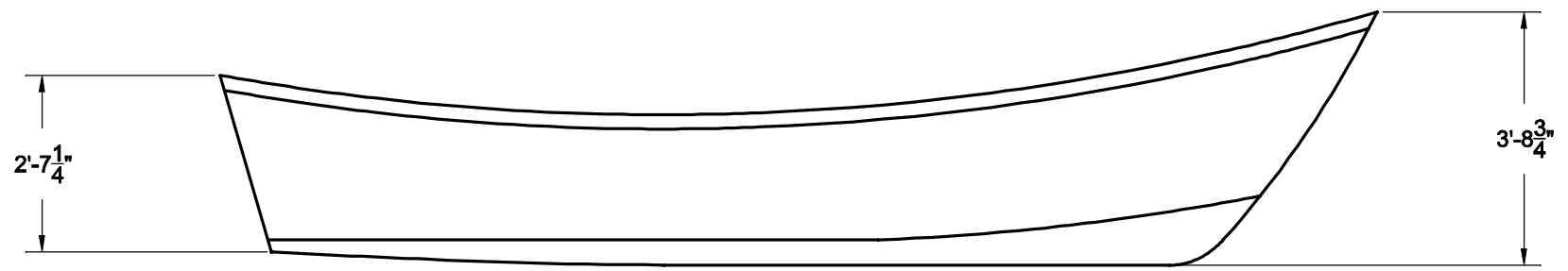
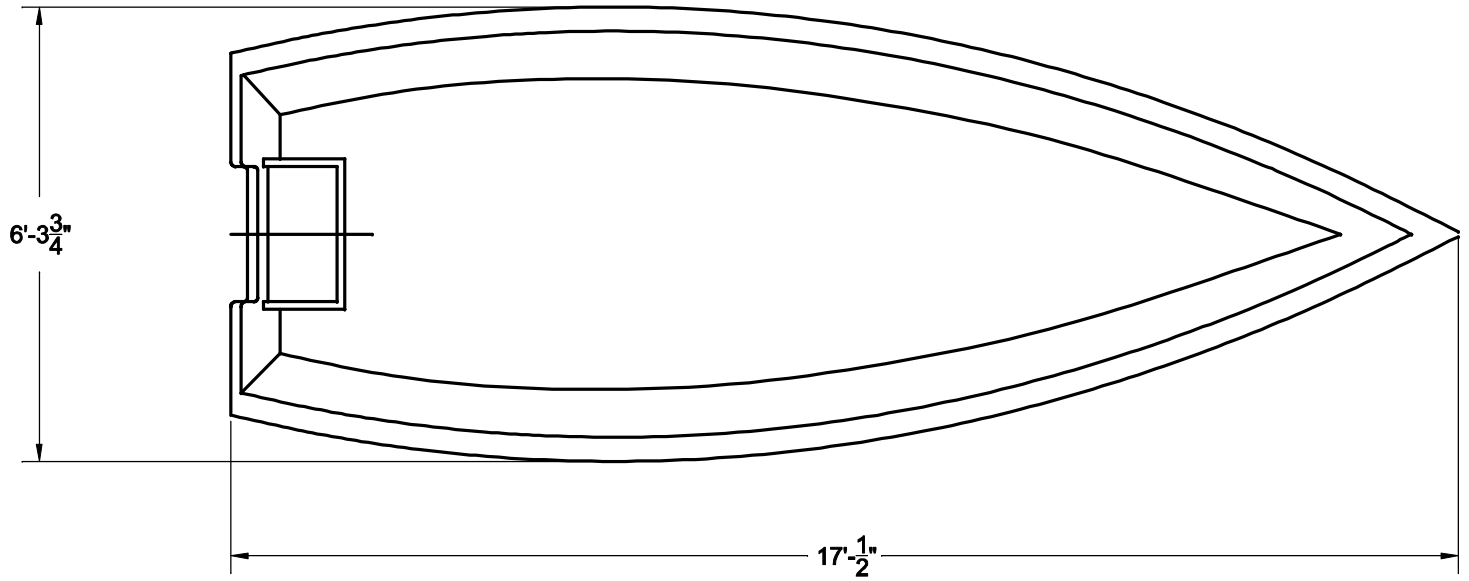

**Spira International, Inc.**  
*Huntington Beach, California*

**KACHEMAK**  
 17' V-BOTTOM CAROLINA DORY

DRAWN BY: J. SPIRA	DATE: 02/16/08	DRAWING NO. KACH01
SCALE 3/4" = 1'		SHEET OF

**NOTICE**  
 THIS DRAWING CONTAINS A PROPRIETARY DESIGN ASSIGNED TO SPIRA INTERNATIONAL, INC. ALL RIGHTS TO DUPLICATE, TRANSFER OR SELL THIS DESIGN ARE EXPRESSLY RESERVED. THE BUYER IS LICENSED TO BUILD ONE ASSEMBLY FROM THESE PLANS.

REVISIONS				
ZONE	LTR	DESCRIPTION	DATE	APPROVED

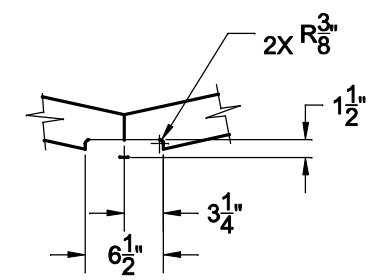
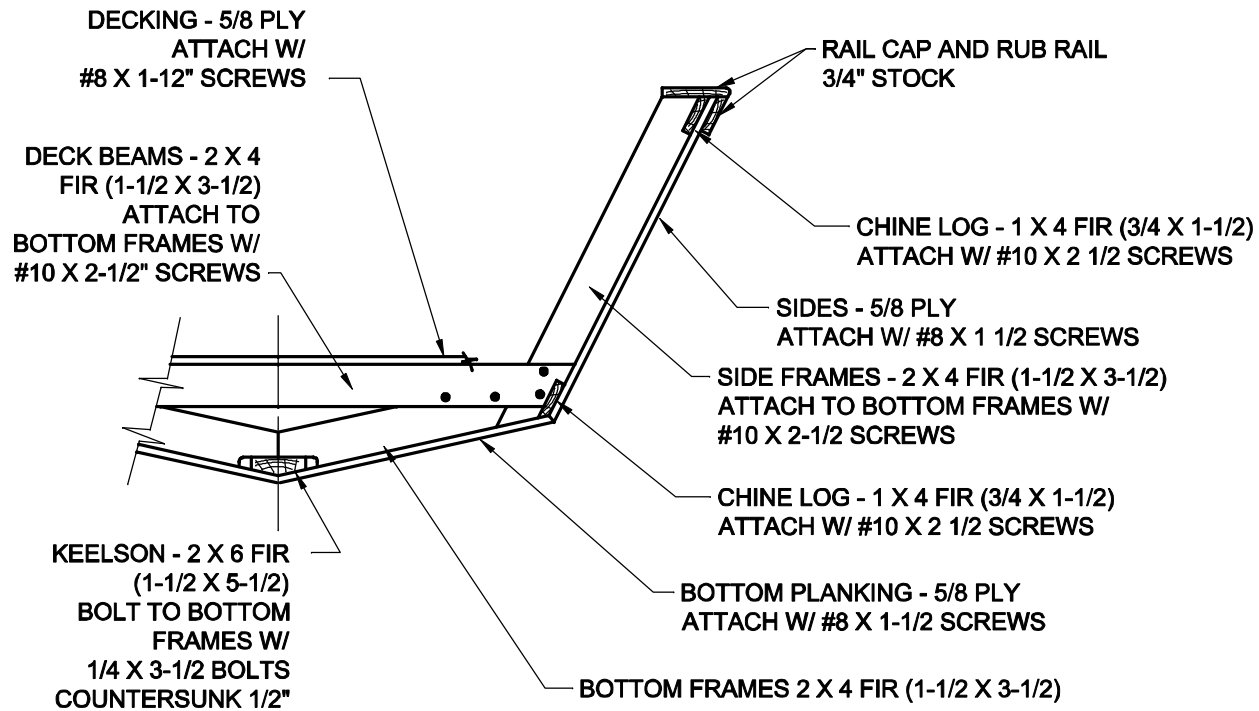

CONSTRUCTION METHOD  
 TYPICAL AT EACH FRAME

KEELSON CUTOUT  
 TYPICAL ALL FRAMES

**SEQUENCE FOR MAKING FRAMES**

NO SCALE

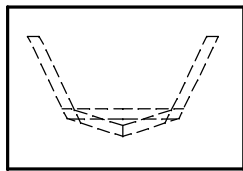

DRAW FRAME ON  
 SCRAP PLYWOOD

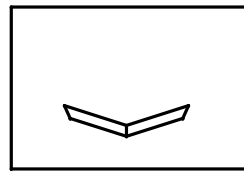

CUT OUT LOWER FRAME  
 ELEMENTS AND LOCATE  
 IN POSITION - EPOXY  
 CENTER JOINT

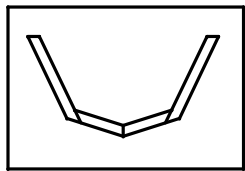

REPEAT FOR SIDE  
 FRAMES - EPOXY JOINT

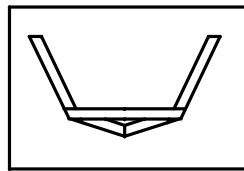

CUT OUT DECK  
 BEAM, LOCATE IN  
 POSITION, EPOXY &  
 SCREW IN PLACE

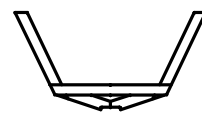

CUT OUT KEELSON  
 NOTCH AFTER EPOXY  
 HAS SET FULLY

**Spira International, Inc.**  
*Huntington Beach, California*

**KACHEMAK**  
**17' V-BOTTOM CAROLINA DORY**

DRAWN BY: J. SPIRA	DATE: 02/16/08	DRAWING NO. KACH04
-----------------------	-------------------	-----------------------

SCALE 3/4" = 1' & NOTED      SHEET    OF